

پروفیل های کرتین وال

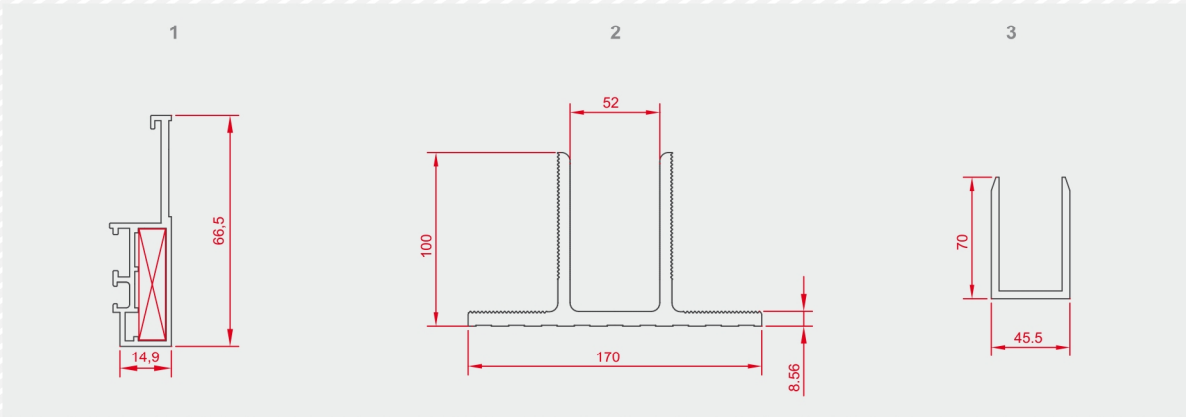

10420

پروفیل اتصال به دیوار
conection to wall beraket
0.725 Kg/m

10430

براکت اتصال به دیوار
conection to wall beraket
7.526 Kg/m

10435

براکت اتصال به کف
conection to wall beraket
4.157 kg/m

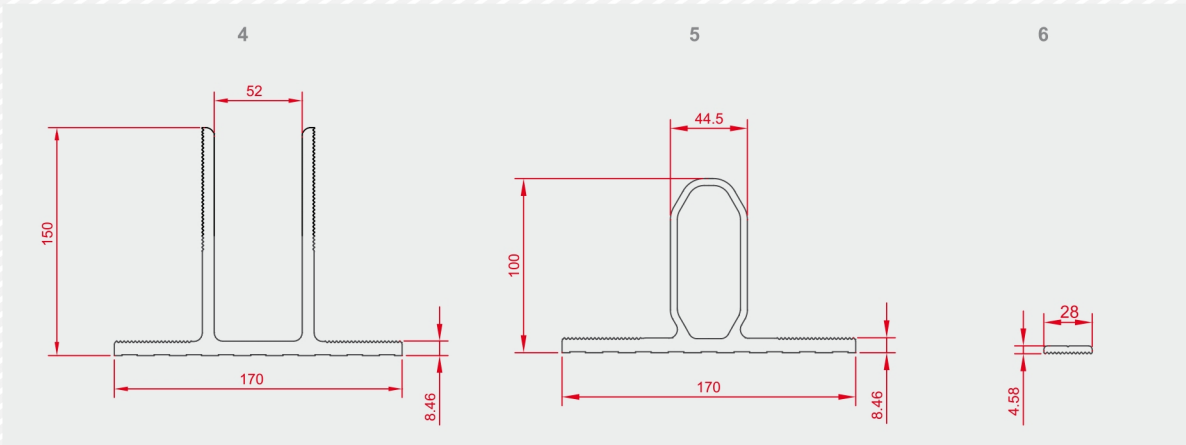

10431

براکت اتصال به دیوار
conection to wall beraket
9.540 kg/m

10433

براکت اتصال به سقف
conection to wall beraket
6.31 kg/m

10434

مهره براکت
conection to wall beraket
0.323 kg/m

Caped Curtain Wall System Fixers List

Profil Number (6metr)	20021	10338	20771	20770
Drawing				
Fixer Name	AP20187 INNER	AP10241 AP10242 AP21035	AP20187 OUTER AP20774 AP5068	AP20773 AP10420 AP5056
Cutting Lenght(Mm)	32	41.3 31.8 31.8	16.6 6 16.6	25.6 25.6 7.9
Weght(Kg/m)	3.087	2.505	3.60	3.60

دیتیل نصب لقمه کشویی

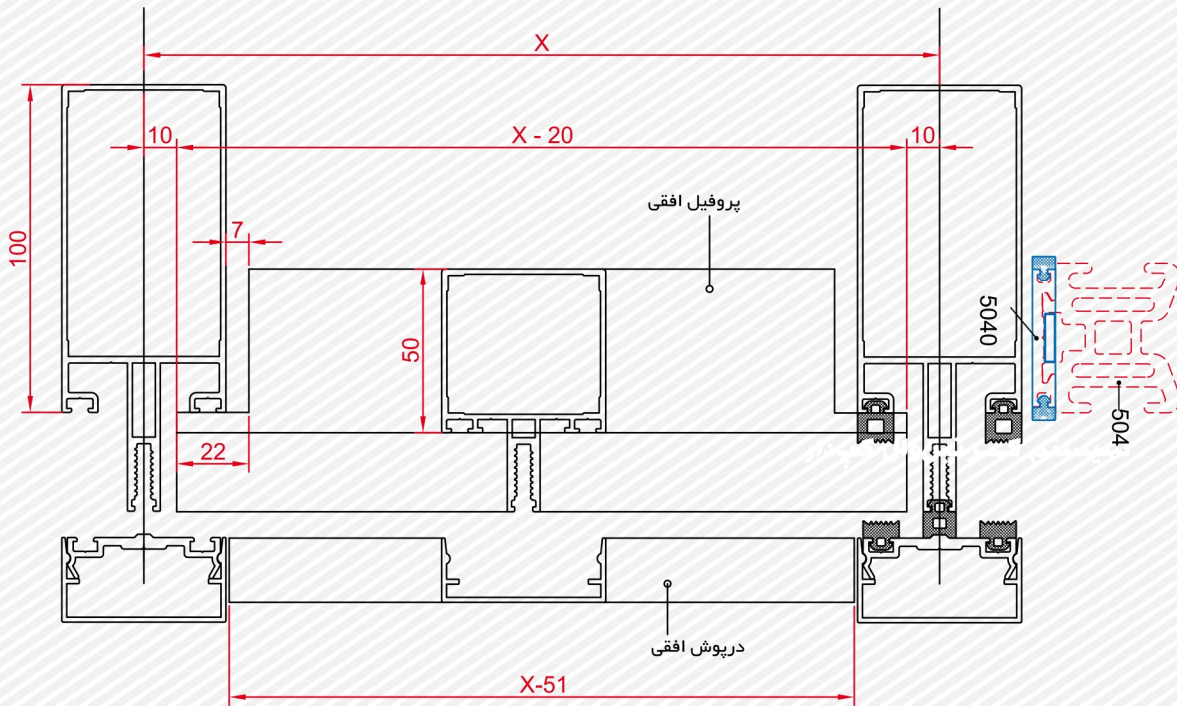

دیتیل نصب لقمه فیکس

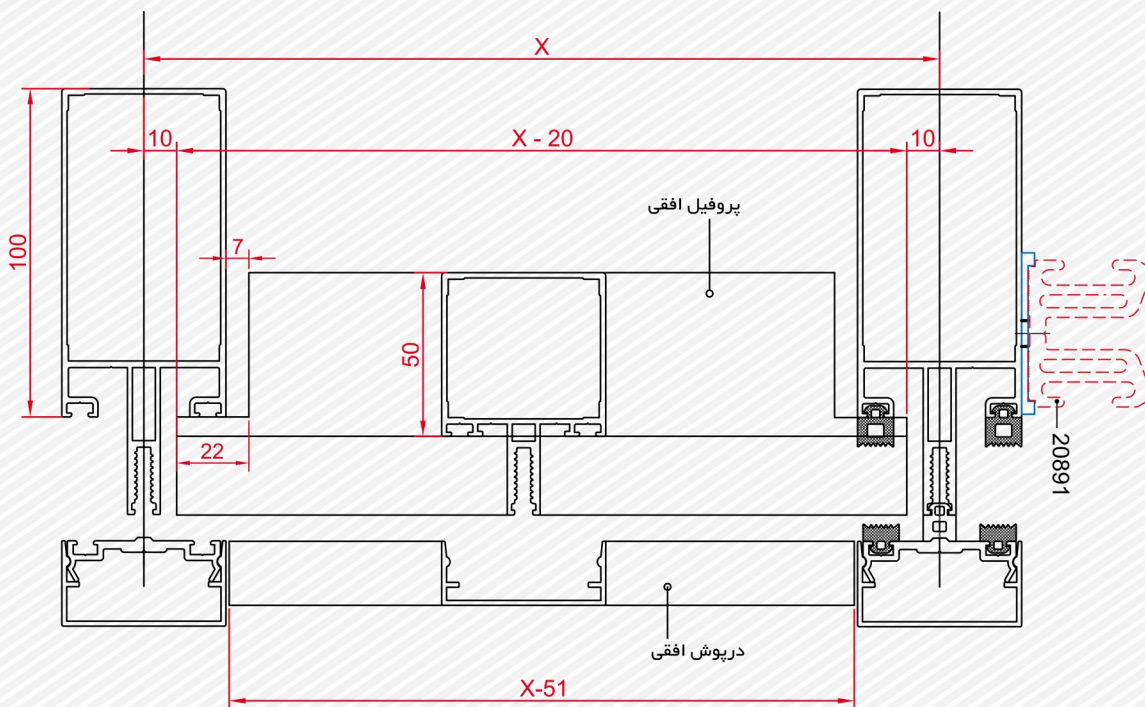

دیتیل کرتین وال

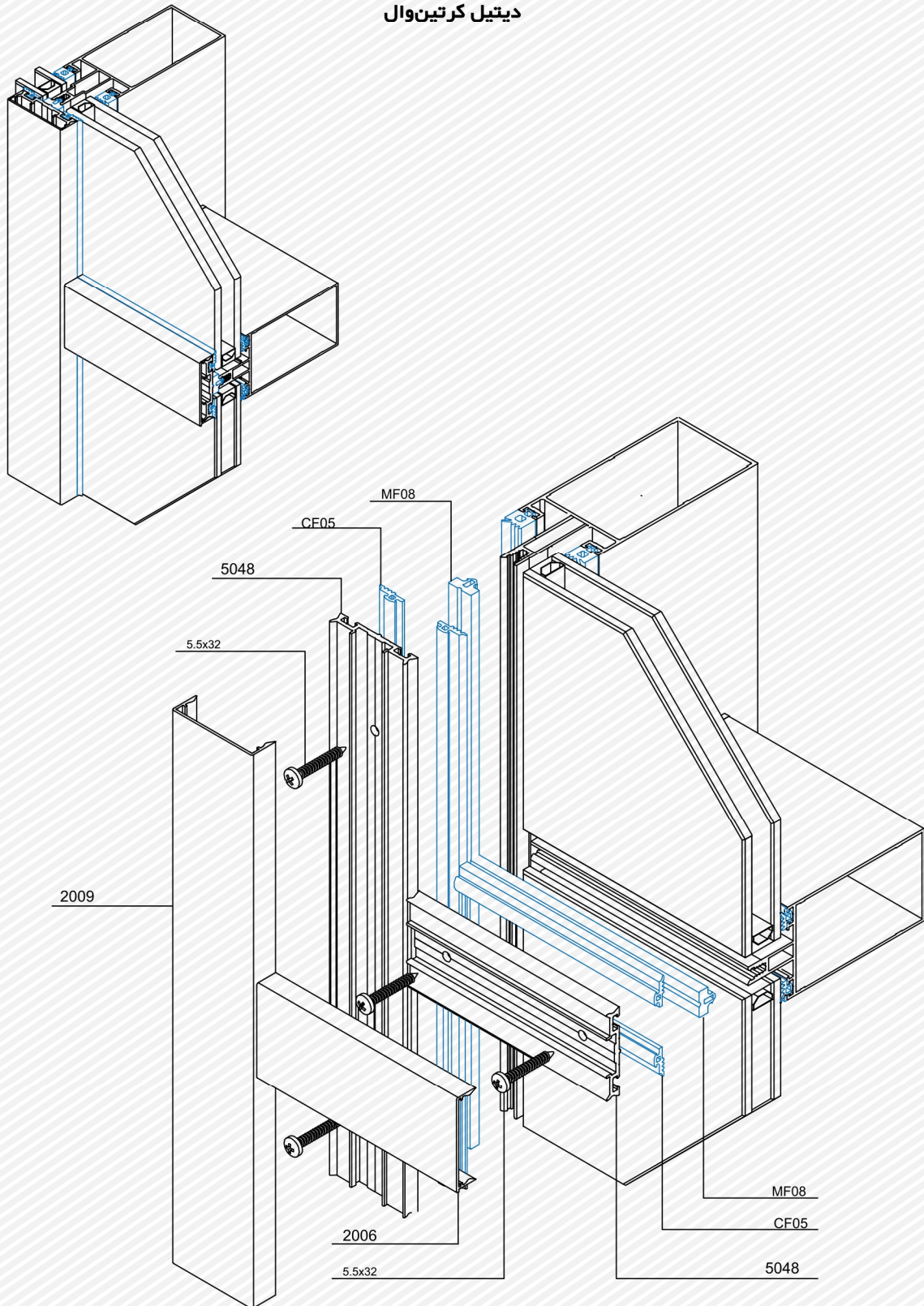

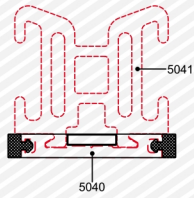

اندازه‌های لقمه کشویی

لقمه 5041

ریل 5040

لاستیک U شکل

	20748	5011	5010	20855	20998
Part no.	20748	5011	5010	20855	20998
Lenght (mm)	41	56	71	97	122
	41	56	71	97	122
	44	59	74	100	125
	EPDM	EPDM	EPDM	EPDM	EPDM
	KG-3-20748	KG-2-5011	KG-1-5010	KG-4-20855	KG-3-20748

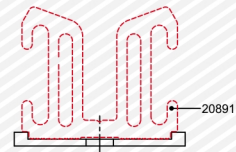

اندازه‌های لقمه فیکس ۲۰۸۹۱

20891

لاستیک U شکل فیکس

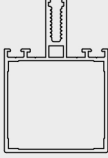
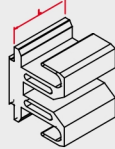
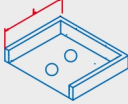
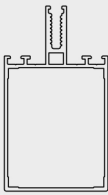
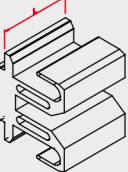
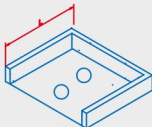
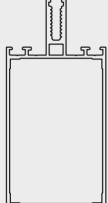
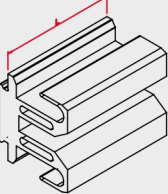
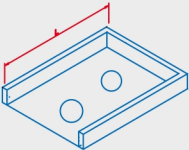
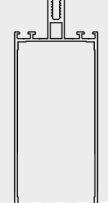
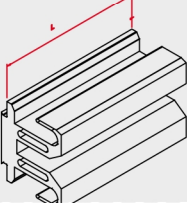
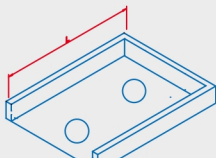
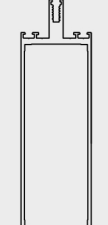
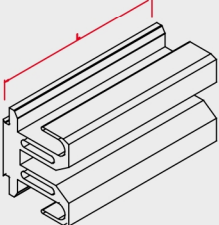
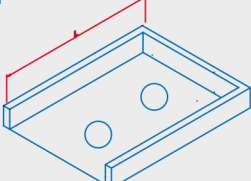
Part no. Lenght (mm)			EPDM 
	20748	41	DG-3-20748 44
Part no. Lenght (mm)			EPDM 
	5011	56	DG-2-5011 59
Part no. Lenght (mm)			EPDM 
	5010	71	DG-1-5010 74
Part no. Lenght (mm)			EPDM 
	20855	97	DG-4-20855 100
Part no. Lenght (mm)			EPDM 
	20998	122	DG-5-20998 125

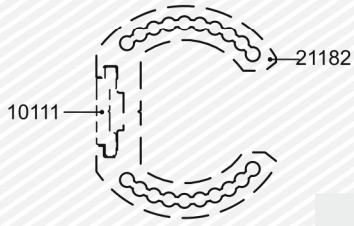

اندازه های برش لقمه ی زاویه در ترنزوم

	Profile no.	لقمه 21182	ریل 10111
Part no. cutting length (mm)	20748	L=41mm	L=41mm
Part no. cutting length (mm)	5011	L=56mm	L=56mm
Part no. cutting length (mm)	5010	L=71mm	L=71mm
Part no. cutting length (mm)	20855	L=97mm	L=97mm
Part no. cutting length (mm)	20998	L=122mm	L=122mm

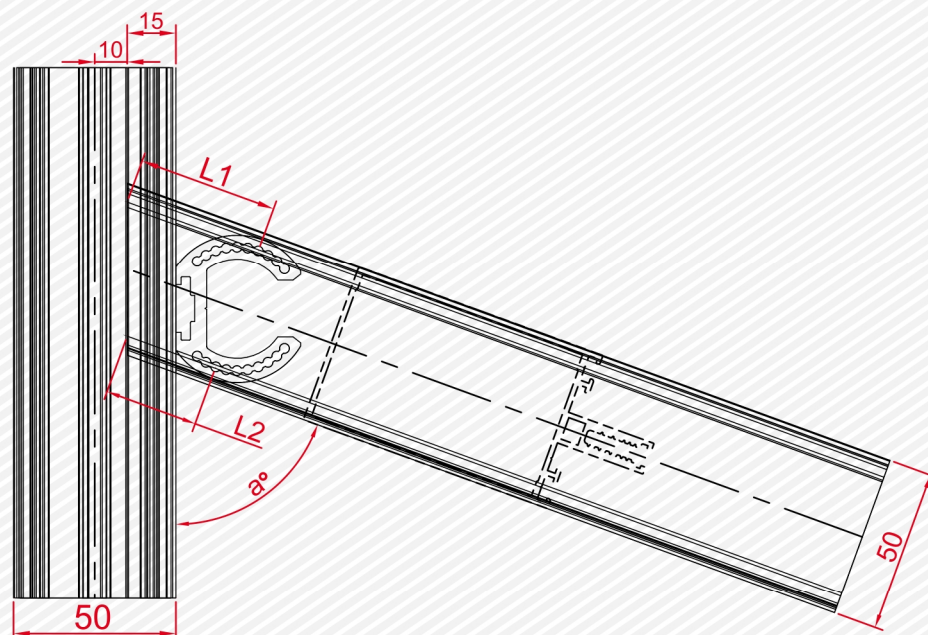

اندازه های نصب به صورت فیکس







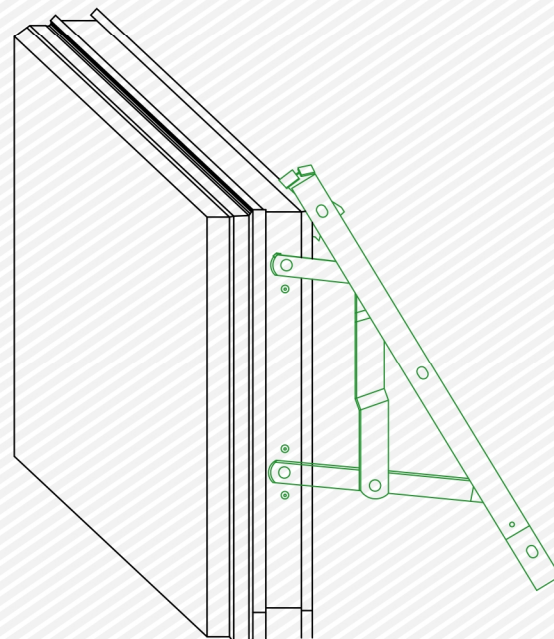
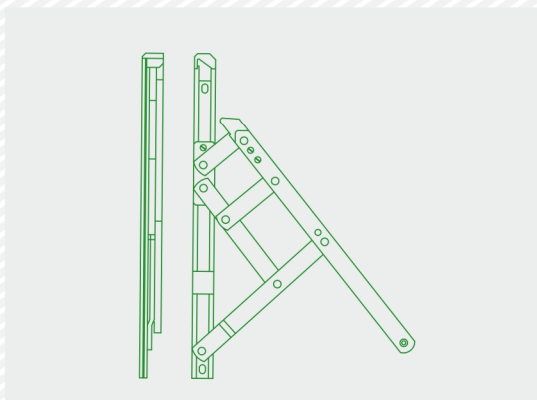
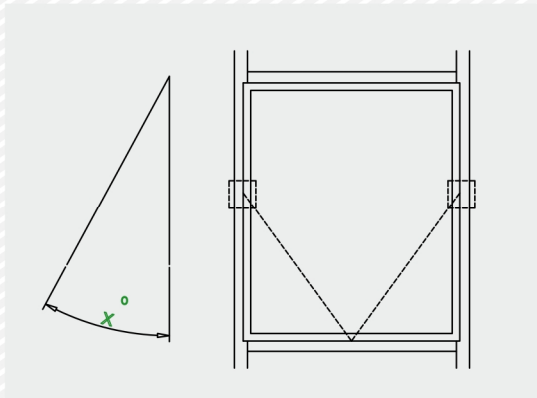











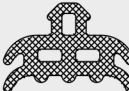

α °	L1 (mm)	L2 (mm)
85	34	33.9
80	37.76	30.89
75	38.55	31.43
70	43.07	28.85
65	44.72	26.53
60	50.27	27.76
55	53.27	29.24
50	60.48	27.75
45	65.6	29.9

کدهای لولای کاردی کرتین وال

GIESSE		GS HD "P"		نوع لولای کاردی باز شو Friction Hinge			اندازه لنگه ی باز شو	
لولای کاردی باز شو Friction hinge	Code	عرض لولای کاردی (mm)	خلامی کار (mm)	طول لولای کاردی (mm)	ماکسیمم درجه ی باز شو	ماکسیمم ارتفاع باز شو (mm)	ماکسیمم عرض باز شو (mm)	ماکسیمم وزن باز شو Kg
S HD-10" P Tipi	08534000N	23	16+0.5	261.5	35°	700.00	1200	50
S HD-12" P Tipi	08535000N	23	16+0.5	317.5	30° / 35°	800.00	1200	60
S HD-14" P Tipi	08536000N	23	16+0.5	353.5	30° / 35°	1000.00	1300	69.5
S HD-16" P Tipi	08537000N	23	16+0.5	414.5	25° / 30°	1200.00	1400	88.5
S HD-18" P Tipi	08538000N	23	16+0.5	458.5	25° / 30°	1400.00	1400	102
S HD-20" P Tipi	08539000N	23	16+0.5	511.5	20° / 25°	1600.00	1500	135
S HD-22" P Tipi	08534000N	23	16+0.5	556.5	20° / 25°	1700.00	1500	137
S HD-24" P Tipi	08534100N	23	16+0.5	602.5	20° / 25°	1800.00	1500	139
S HD-28" P Tipi	08534200N	23	16+0.5	707.5	10° / 15° / 20°	2000.00	1500	155

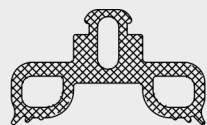

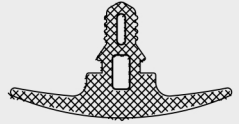
لاستیک‌های سیستم کرتین‌وال

	EPDM 	EPDM 	EPDM 	EPDM 
Part no.	CF03	CF04	CF05	CF05 A
	EPDM 	EPDM 	EPDM 	EPDM 
Part no.	CF07	CF09	CF13	MF08
	EPDM 	EPDM 	EPDM 	EPDM 
Part no.	OYF40	TF40	CYF10	CTFC30
	EPDM 	PVC 	EPDM 	EPDM 
Part no.	1008	NPP028	YF03	YF09
	EPDM 	EPDM 	EPDM 	EPDM 
Part no.	KYF10	OYF30	TF20	KTF20
	EPDM 	EPDM 		
Part no.	KF10	2036		